

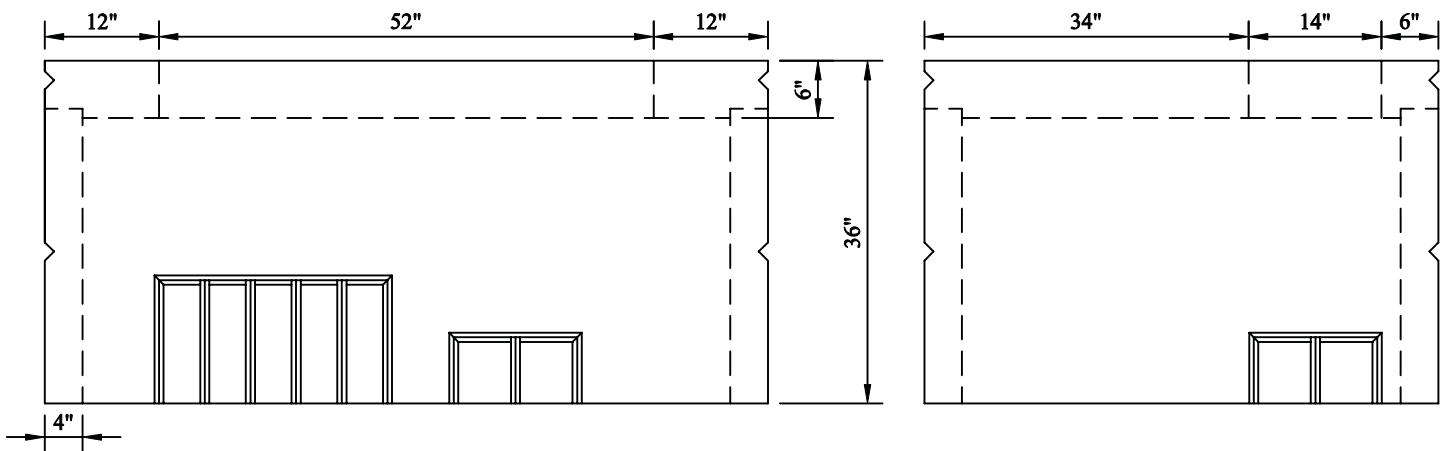

Utilities

Northeast Utilities
P-013 Transformer Pad
76" x 54" x 36"

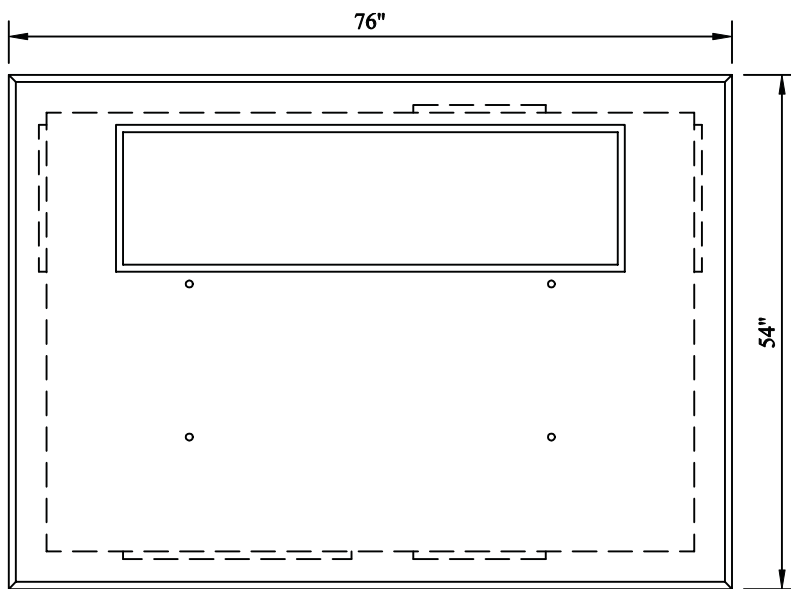

NOTES:

1. Minimum Concrete Compressive Strength: 4,000 PSI @ 28 Days.
2. Steel reinforcement ASTM A615, Grade 40.
3. Contractor shall conform to Northeast Utilities standard specifications.